

32
SINCE 1984
YEARS OF
YOUR TRUST
Dawn®



ZORA™

**WITHOUT FRAME
CONCEALED CISTERN
ZD-2000**

- INSTALLATION
- MAINTENANCE
- WARRANTY GUIDE

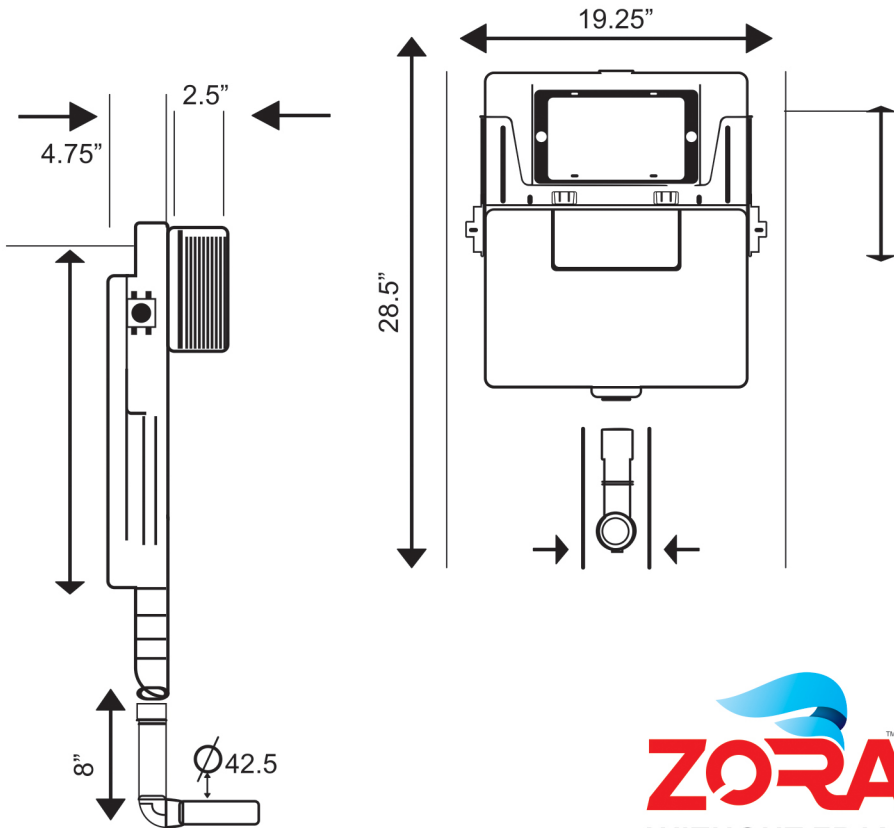

ZORA[™]
WITHOUT FRAME
CONCEALED CISTERN
ZD-2000

LIST OF PARTS INCLUDED

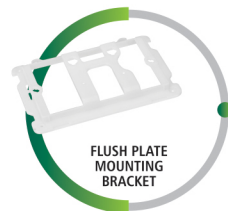
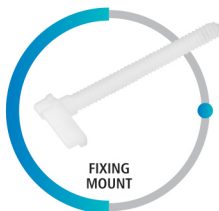
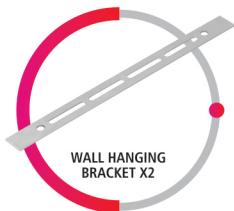
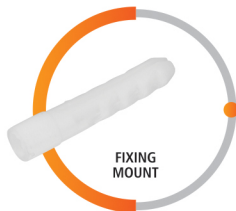
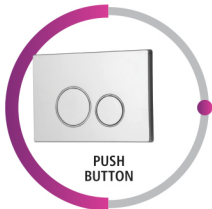

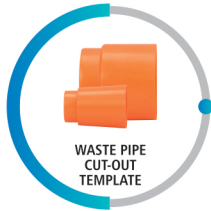
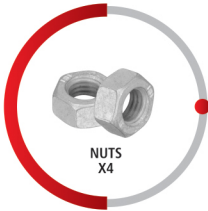
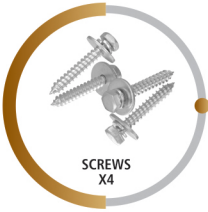



ZORA[™]

WITHOUT FRAME
CONCEALED
CISTERN

ZD-2000

PARTS
COLLECTION



PARTS



ZORA[™]

3



INSTALLATION, MAINTENANCE & WARRANTY GUIDE

ٹینک بریکٹ اتار کر وال بریکٹ لاک کر لیں اور
نوسے ڈگری موڈ کر ٹینک کے ساتھ لگا دیں۔



ڈریل کرنے کے لئے اپنی مقررہ اُوچائی پر نشان لگائیں۔
اور ڈریل کریں۔

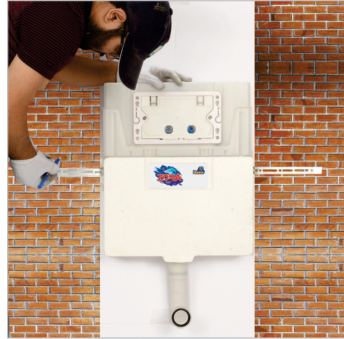

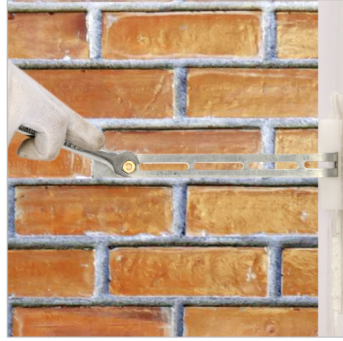

ٹینک کو سکرپو کی مدد سے لگادیں۔



ٹینک الٹیو اور نوے ڈگری الٹیو کے سوراخ میں 5.5" کا فرق پورا کریں۔



HOW TO INSTALL



ZORATM
CONCEALED CISTERN

8

ZORATM

HOW TO INSTALL

ٹینک میں پانی چلانے سے پہلے پائپ میں
موجود Depris کو صاف کر لیں اس کے
لیئے مندرجہ ذیل طریقہ پر عمل کریں۔

STEP 1



فرنٹ پیٹ کے لاک کو نیچے دبا کر باہر نکال لیں۔

STEP 2

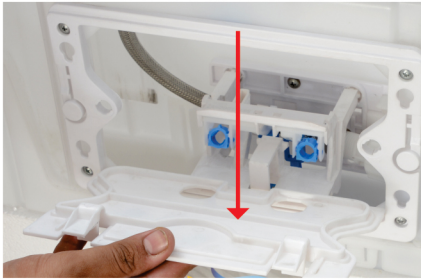

پیٹ کو باہر نکال لیں۔

STEP 3



Water Inlet Cock بند کر لیں۔

STEP 4



ٹاک کو دبا کر Working Plate کو باہر نکال لیں۔

STEP 5



دبا کر باہر نکال لیں۔

STEP 6

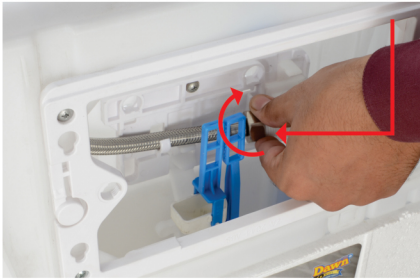

نکشن پائپ کو Fill Valve سے اتار لیں۔

STEP 7



Water Inlet Cock بند کر لیں۔

پائپ کو باہر نکال کر Water Inlet Cock کو چلائیں 30 سیکنڈ تک پانی کو چلتا رہنے دیں۔ تاکہ پائپ صاف ہو جائے۔

10

ZORA™

CLEANING OF DEPRIS

STEP 1

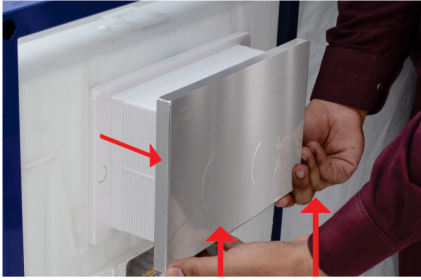

Push Plate کو اوپر کی طرف Push کر کے باہر کی طرف نکال لیں۔

STEP 2



STEP 3



Screw کو Counter Clockwise گھما کر باہر نکال لیں۔

STEP 4

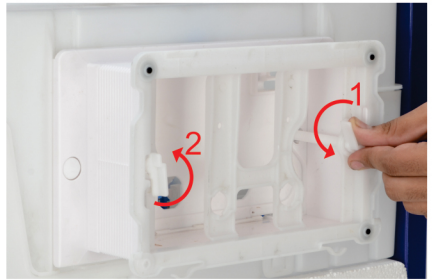

Push Plate کی بیک کو اتارنے کے لیے Fix Screw کو گھما کر اتار لیں۔

STEP 5



STEP 6



Front Plate کو اتار دیں۔

STEP 7



Screw Working Plate کو اتار دیں۔

STEP 8



Water Inlet Cock بند کر لیں۔

فلٹر صاف کرنے کا طریقہ

نوٹ:
ہر 3 سے 4 ماہ بعد فلٹر کو صاف پانی سے دھو لیں۔

STEP 1



فلٹر صاف کرنے کے لئے کنکشن پائپ کو Fill Valve سے اتار لیں۔

STEP 2



فلٹر کو باہر نکال لیں۔

STEP 3



فلٹر کو صاف پانی سے دھو لیں۔

STEP 4



STEP 5



Fill Valve میں لگا کر کنکشن پائپ لگا دیں۔

STEP 1

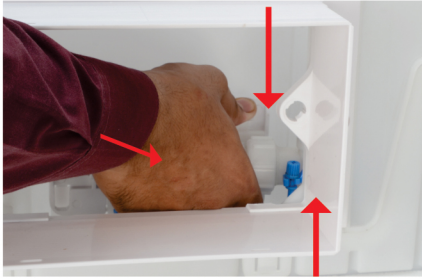

Fill Valve کے Clip کے لاک کو پیچھے دبا کر باہر نکال لیں۔

STEP 2



STEP 3

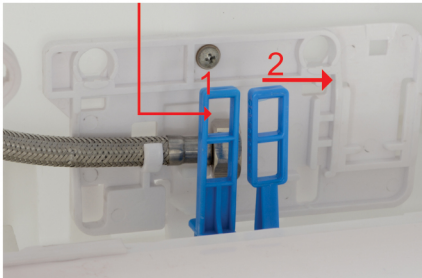

Flush Valve کے لیورز کو دائیں طرف گھما کر پیچھے کر لیں۔ پھر اسکے لاک کو نکال لیں۔

STEP 4

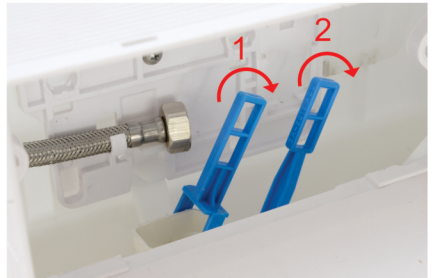

STEP 5



Flush Valve کو تڑپھا کر کے نکال لیں۔

STEP 6



STEP 7



STEP 8

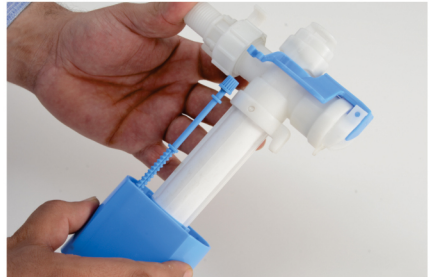

STEP 9

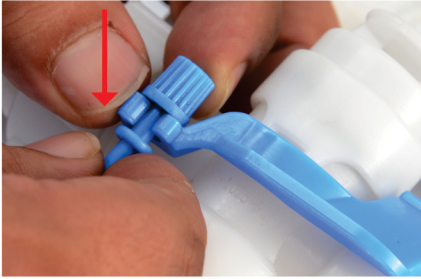

Fill Valve کو صاف کرنے کے لیے Screw کو لاک سے الگ کر لیں۔

STEP 10

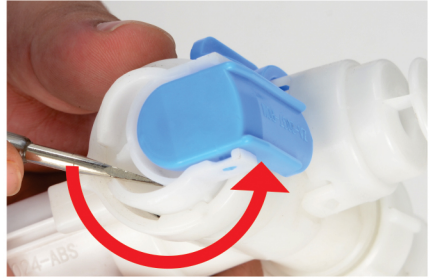

STEP 11

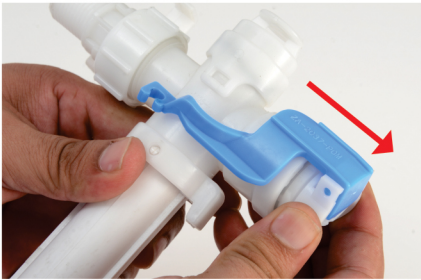

STEP 12



Silicone Membrane کے کور کو اتار لیں اور ٹل کے صاف پانی سے دھو لیں۔

STEP 13



STEP 14



STEP 15



Silicone Membrane کے کور کو اتار لیں اور تل کے صاف پانی سے دھولیں۔

STEP 16



Flush Valve کی Silicone Seal کو اتار کر تل کے صاف پانی سے دھولیں۔

Concealed Cistern Warranty

General Guidelines to Maintain chrome plated Flush plate

To get the best results and the longevity of the product, Follow the below mentioned guidelines:

- Keep your chrome plated Flush plate free from any deposits & clean it with water-soaked soft towel or bathing soap solution once or twice a day to keep the plated surface clean.
- Use only non-acidic cleaning/detergent agents which contain no acids or chemicals such as flush cleaner. Avoid the use of salt or vinegar-based cleaning agents to remove scale or scale-related stains. They may damage the surface or finish of our product.
- Always test your cleaning agents on an inconspicuous area on the product before applying it to the entire surface.

Protect your product from:

- **Water Scaling**

Due to presence of minerals and salt in water, scaling is formed on the product if it is not cleaned regularly. The products should be cleaned gently at regular intervals. Also take extra care to clean the edges and corners of the products because these areas are more vulnerable for scale settling. The property of water being used is very important for your plumbing installations (pipes etc.), as well as for your own hygiene.

- **Acid Fumes**

When we clean the tiles or floors in the bathroom with cleaning agents which contain acids or chemicals, acid fumes are formed. Due to these acid fumes, a green color layer is formed on the products resulting in damage to the outer finish or coating.

- **Scratching while cleaning**

Scratching or scrubbing occurs due to hard nature of cloth or coarse cleaning powder being used for cleaning. Use a gentle fluffy soft cloth for cleaning the surface.

- **Atmospheric Conditions**

This condition applies mostly to salt content in the air in coastal area, sometime the air reacts and black spots emerge on the surface of product. Therefore, the product is required to be cleaned regularly. At the time of installation of the products, cover the products with the cloth covers provided in packaging or with polythene till the time you actually start using them.

Warranty Terms & Conditions

1. DAWN PLASTIC gives 10 years warranty to the concealed cisterns.

Product	Residential Warranty Period	Commercial Warranty Period
Concealed Bodies & Fittings, Flush Valve & Fill Valve	10 Years	5 Years
Chrome Plated Flush Plate	5 Years	3 Years
Seales & Washers	5 Years	3 Years

2. Warranty will be applicable only if the products at all times have been used & maintained according to the terms of this warranty and has not been improperly or negligently handled and is not maintained in accordance to maintenance guidelines given.

3. Warranty period will start from date of invoice & shall automatically terminate upon the expiry of the warranty period even if the product has not been installed or not in use after purchase.

4. The original invoice must be preserved by the customer and produced whenever required with customer name and place of purchase.

5. This warranty does not cover installation or any other labor charges associated with the job work or re-installation of products.

6. This warranty does not extend to incidental or consequential damages, losses or expenses arising out of ignorance, negligence, willful damaging, damage in transit, mishandling, unauthorized alteration or repair and accidents either due to faulty installation or otherwise. This warranty does not cover consequential damage / defects of any nature resulting from improper selection / improper installation and use of the product.

7. DAWN PLASTIC, at its discretion, may retain any part or product replaced during the warranty period.

8. DAWN PLASTIC will not be responsible for any incidental, consequential or any other damage or cost or expense, including but not limited to loss of profit or removal, transportation, handling or re-fixing costs and expenses & liability under any circumstances is maximum to the purchase value of the product.

9. DAWN PLASTIC shall not be liable to Customer claiming the warranty under the terms of condition of this Limited Warranty for damages caused due to the act of God or the public enemy, any accident, explosion, fire, storm, earthquake, electric storms, tornado, flood, casualty, lockout, strike, labor conditions, unavoidable accident, natural calamity, or any other circumstance or event or by any enactment of law, or by order of any legally constituted authority, or by any other similar cause which is beyond its reasonable control of the party.

10. The company or its Authorized dealer agents certified by the company will repair or replace with new or functionally operative parts free of charge, any part or parts of the product when it is identified that the defect is solely attributable to manufacturing fault or workmanship and not caused due to improper installation or usage. Spares shall be charged according to the conditions of the warranty coverage listed.

Dawn plastic review each specific case and assess whether the warranty prerequisites have been met and whether there are grounds for exclusion due to above reasons then warranty is considered void.



INSTALLATION VIDEO LINK

Made in 
Pakistan

Dawn[®]

Plastic Industries

Plot # B-2/3 , S.I.E 2, Gujranwala.
Tel:055-4285007-4285008
Cell:0300-8743154-0300-0600154
www.dawnplastic.com.pk